

# Installation Instructions

Eibach Inc. 264 Mariah Circle Corona, CA 92879  
USA Tech Support 800-507-2338 ext. 114



## PRO-TRUCK COILOVER 2.0: E86-82-105-01-20

4<sup>TH</sup> Gen Toyota Tacoma

### Notes

Unless otherwise instructed, torque all fasteners to factory specifications.

### Kit Contents

Description	Part Number	Quantity
Front Coilover	82134.9003	2
2.0 Spanner Wrench	ETCO2.0	1
Lower Bushing Spacer	8001568	2

### Installation Notes

#### Read all instructions before beginning installation

- Only qualified mechanics experienced in the installation and removal of suspension components should perform this installation.
- Use of a hoist and screw jack is highly recommended and will substantially reduce installation time.
- Never work on or under a vehicle unless it is properly supported by safety stands and wheels are blocked.
- Never use impact wrenches or impact guns to install or remove shock absorber piston components, shafts and Piston rod nuts.
- All Eibach springs should be installed with the Eibach logo right-side-up. All original stock spring isolators and dampers should be retained from the stock springs when installing Eibach PRO-LIFT springs.
- After Installation, inspect and adjust the following: Wheel Alignment; tire/wheel fender clearance when using aftermarket wheels or tires; brake line clearance and attachments; anti-lock-brake system sensors.
- Tire Rotation: In order to increase the life of your tires, it is recommended to rotate yours tires every 3,000 miles.

# FRONT INSTALLATION



Step 1. Raise the vehicle on a suitable hoist and support it with the proper safety equipment. Use a 21mm socket to remove both front wheels. **Note:** Never work on or under a vehicle that is not supported by the proper safety equipment.

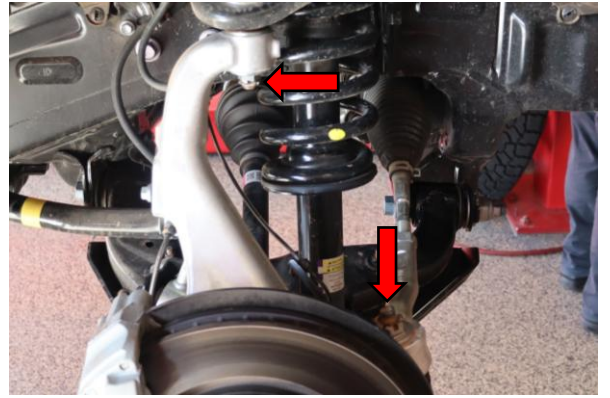

Step 2. Remove cotter pins from the castle nuts at the upper ball joint and tie rod ball joint.

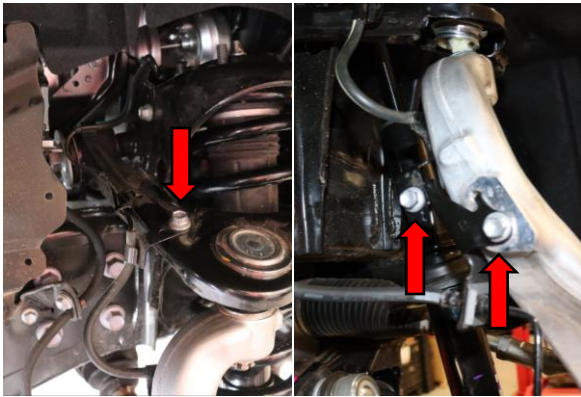

Step 3. Remove three 12mm bolts securing brake line and wheel speed sensor harness brackets.

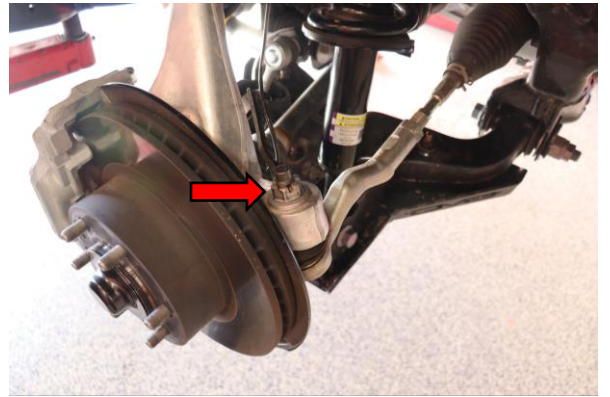

Step 4. Loosen but do not remove 24mm tie rod ball joint nut.

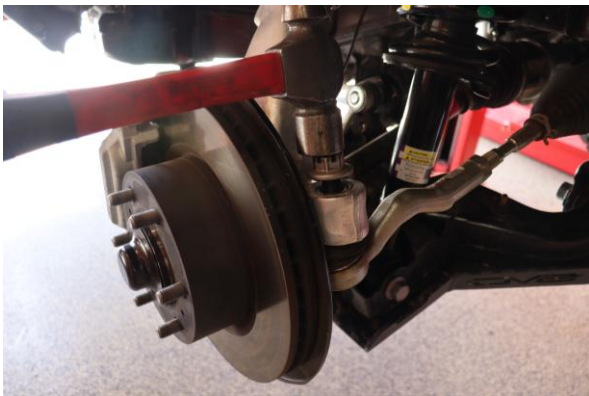

Step 5. Use a hammer to separate the tie rod ball joint from the spindle. Remove the 24mm tie rod ball joint nut. Remove the tie rod ball joint from the spindle.



Step 6. Remove 19mm bolt securing the sway bar end link to the lower control arm.

## FRONT INSTALLATION

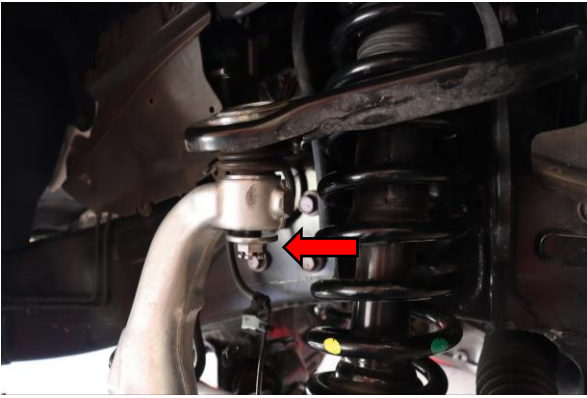

Step 7. Loosen, but do not remove the 19mm nut securing the spindle to the upper control arm.



Step 8. Use a hammer against the flat portion of the spindle to shock the upper ball joint and allow it to lift out of the spindle.



Step 9. Use a strap and secure the spindle to the frame to prevent damage to the axle CV joints.



Step 10. Use a pry bar against the spring coils and the upper control arm to give the upper ball joint slack in the spindle. While holding pressure on upper control arm, remove 19mm upper ball joint. Slowly allow upper control arm to rotate up and away from spindle. Allow spindle to rest against installed strap.

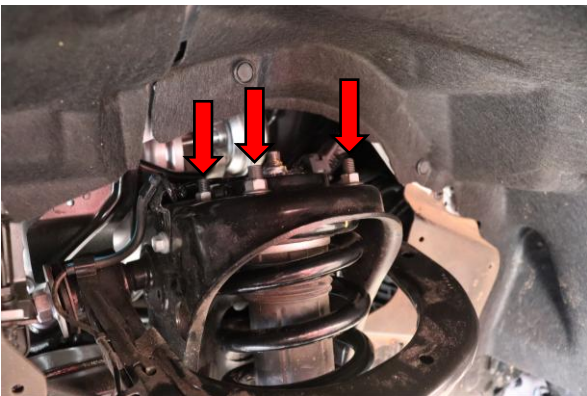

Step 11. Remove the four 14mm top hat nuts securing shock assembly to the frame.

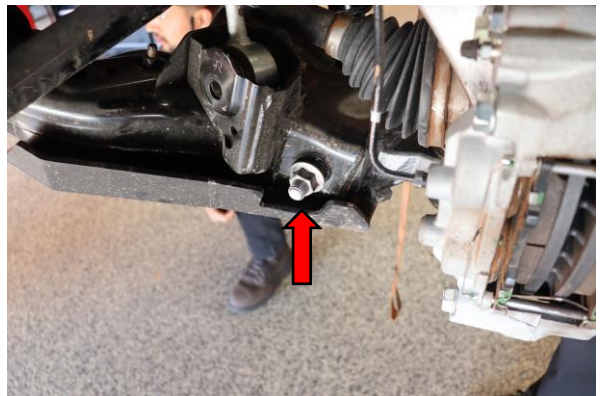

Step 11. Remove 22mm nut from lower shock mount bolt. Pull bolt from opposite side to remove.

## FRONT INSTALLATION



Step 12. Allow lower control arm to drop down slightly and rotate the bottom of the shock assembly toward the outside of the truck.

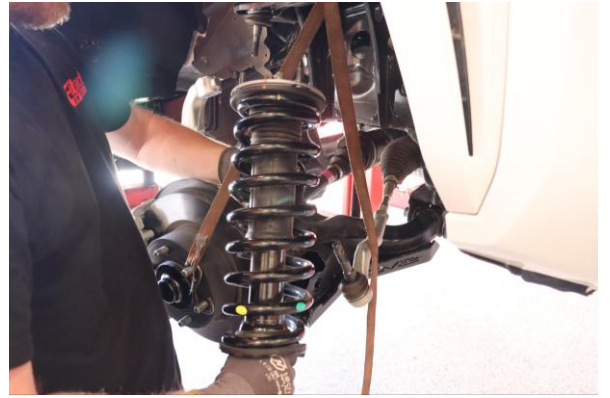

Step 13. Lower the shock assembly out down and out of the upper control arm and remove shock assembly from the truck.



Step 14. Install the new coilover.



Step 15. Install the supplied spacers on either side of the lower shock bushing. The flat side of the spacer will face away from the bushing when installed correctly.



Step 16. Install the lower shock mounting bolt. Install 22mm nut on opposite side and tighten to factory specification.

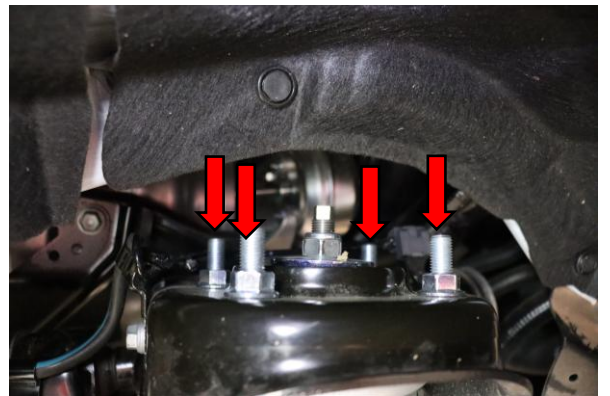

Step 17. Use a 14mm wrench to tighten four upper shock mounting nuts to factory specification.

## FRONT INSTALLATION

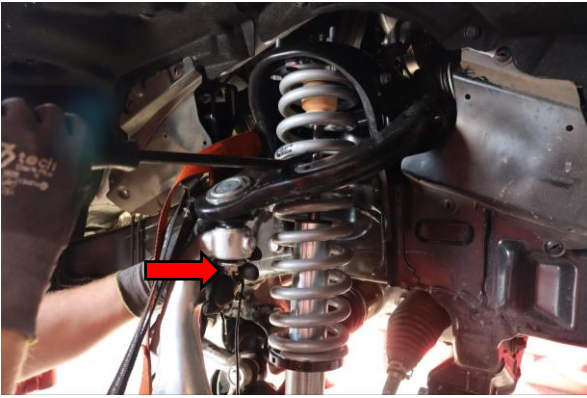

Step 18. Use a pry bar against upper control arm and spring coil to lower the upper control arm into the spindle. Install 19mm nut onto the ball joint finger tight and remove pry bar. Remove the strap supporting the spindle installed on step 9. Tighten 19mm upper ball joint nut to factory specification.

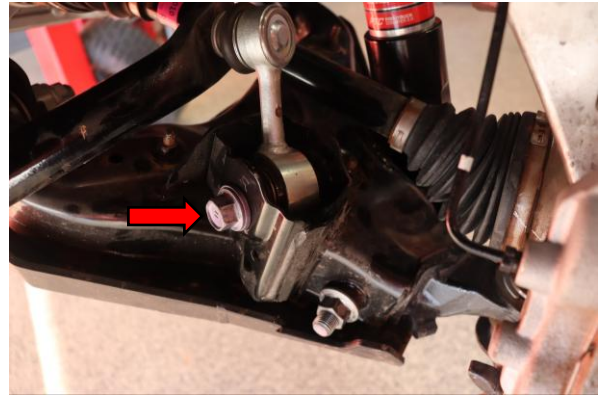

Step 19. Install 19mm bolt securing sway bar end link to the control arm. Tighten to factory specification.

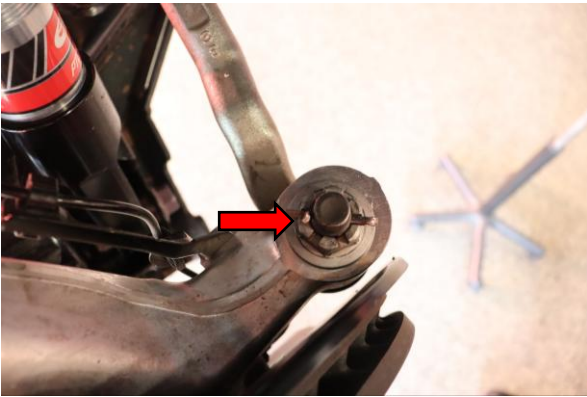

Step 20. Install outer tie rod ball joint into the spindle. Install 24mm nut onto the outer tie rod ball joint. Tighten to factory specification.

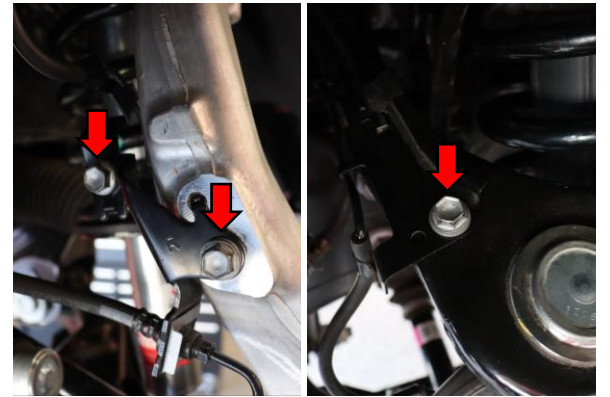

Step 21. Install three 12mm bolts securing the brake line and wheel speed wiring harness. Tighten to factory specification.

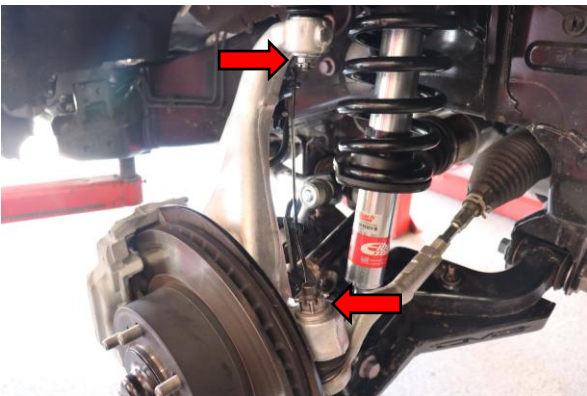

Step 22. Reinstall cotter OE cotter pin in upper ball joint and install new cotter pin in outer tie rod end ball joint.



Step 23. Install both front wheels. Use 21mm to torque lug nuts to factory specification.

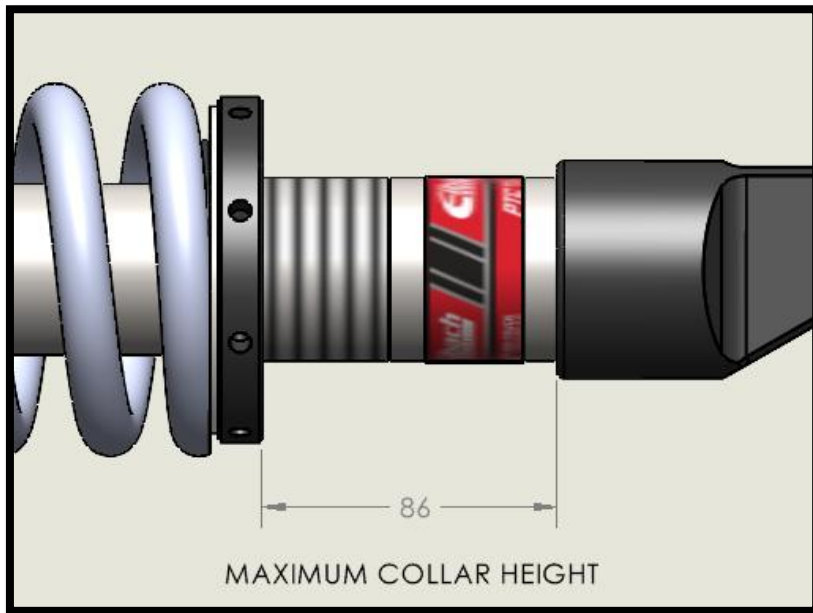

**NOTE: DO NOT GO ABOVE A SPRING COLLAR HEIGHT OF 86mm FROM BOTTOM OF COLLAR TO BASE, AS SHOWN OR ELSE DAMAGE TO THE SHOCK AND SUSPENSION WILL OCCUR**

---